

Misure / Measures

Dettagli / Details

- Struttura materiale in truciolare nobilitato
- Maniglie e piedini verniciati cromo satinato
- Guide cassetti in metallo
- Contiene 2 ripiani regolabili
- Mobile montato
- *Material structure in engineered wood*
- *Chrome-plated feet and handles*
- *Metal drawer runner*
- *Inside: 2 adjustable shelves*
- *Assembled furniture*

Cabinet

Top

Schiena
Backrest
Sp. 3mm

Sp. 25mm

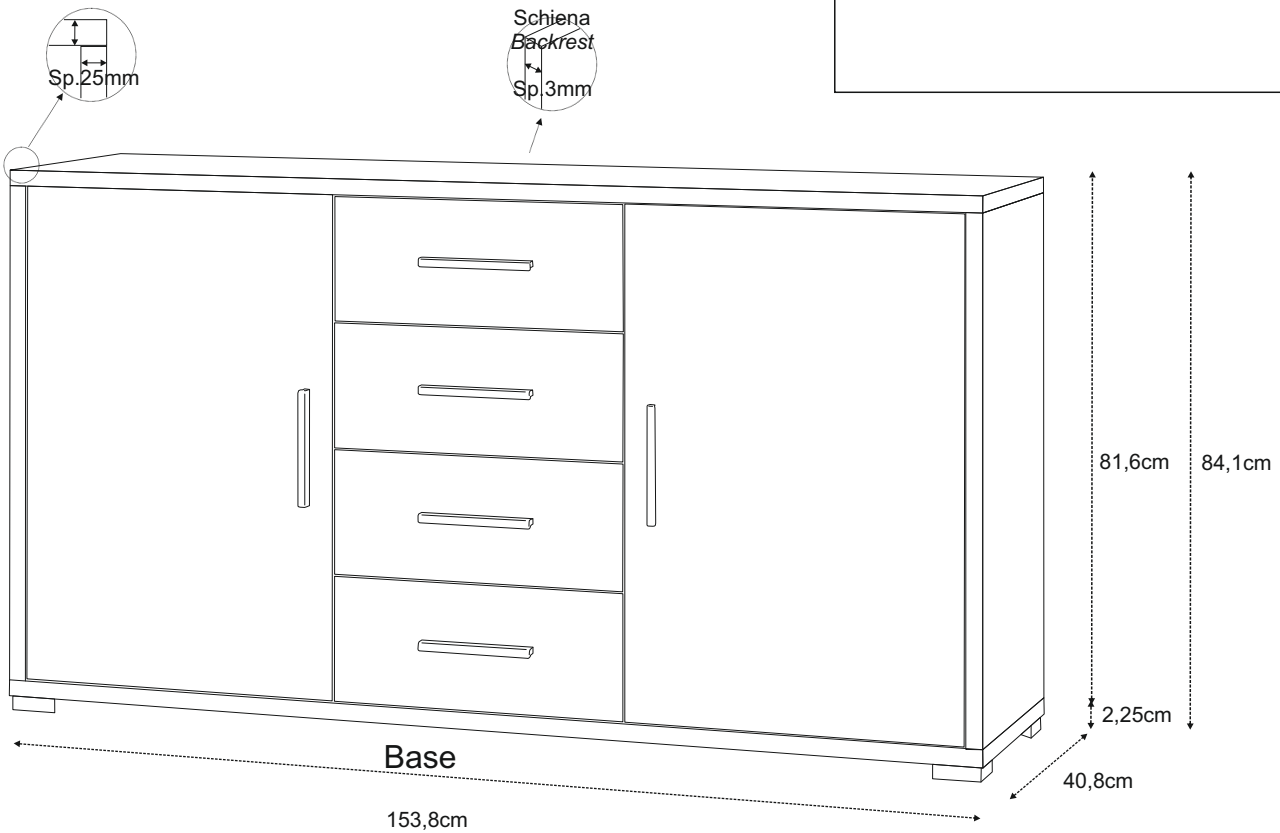

Base

153,8cm

81,6cm

84,1cm

2,25cm

40,8cm

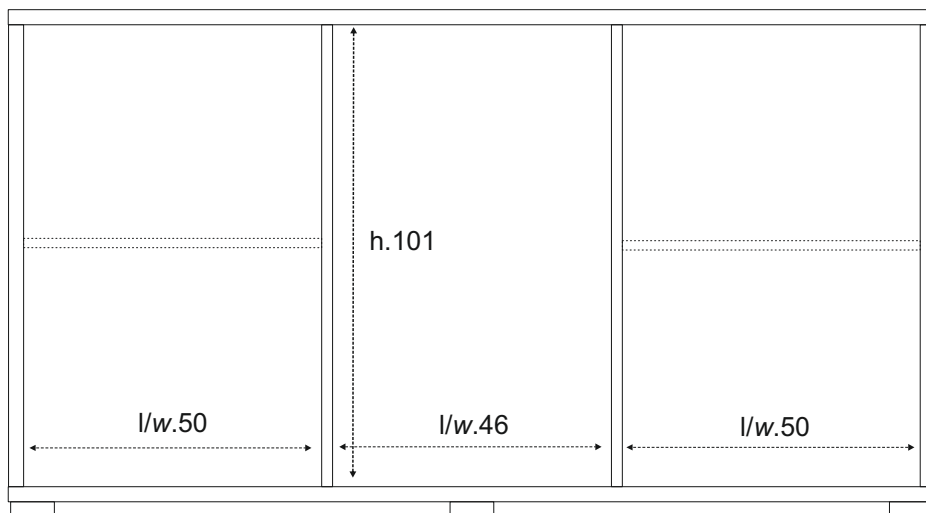

h.101

l/w.50

l/w.46

l/w.50





Ripiano
Shelf

Sp. 10mm

36,4cm

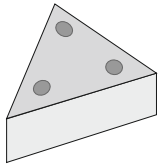
31,2cm

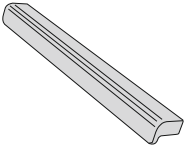
Componenti / Equipment

<p>1</p> <p>Piede cromo satinato Chrome-plated feet</p>  <p>5 pz</p>	<p>2</p> <p>Vite TC M4,5x16 zincata Screw TC M4,5x16 galvanized</p>  <p>12 pz</p>	<p>3</p> <p>Maniglia verniciata cromo satinato Chrome-plated handle</p>  <p>6 pz</p>	<p>4</p> <p>Vite TC M4x20 zincata Screw TC M4x20 galvanized</p>  <p>10 pz</p>	<p>5</p> <p>Reggipiani Support shelves</p>  <p>14 pz</p>
--	---	--	---	--

Istruzioni di montaggio / Assembly Instructions

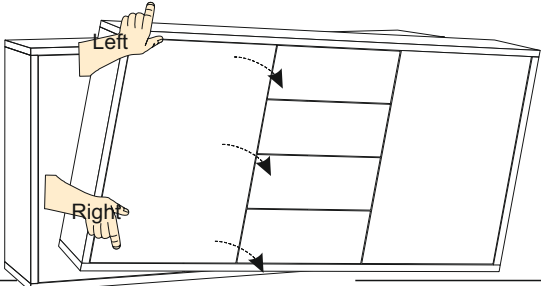
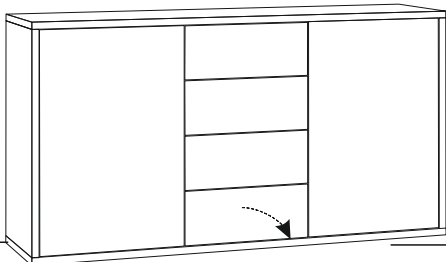
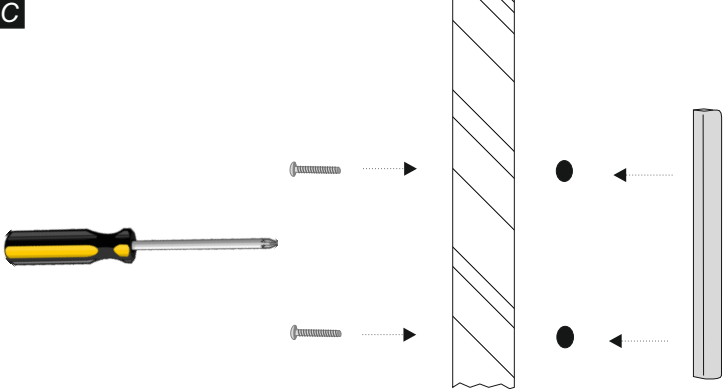
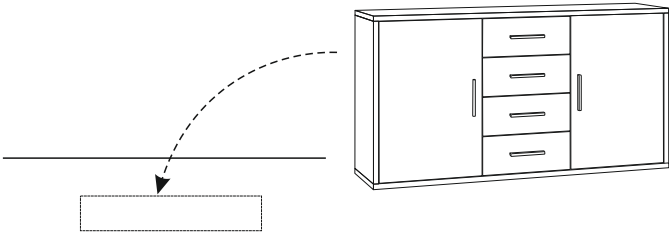
<p>A</p>  <p>Estrarre il mobile dall'imballo e posizionarlo in piedi come mostrato in figura, quindi inclinarlo per permettere l'apertura delle ante. ATTENZIONE: trattenere il mobile con una mano onde evitarne la caduta. Extract the cabinet from the packaging and put it in a vertical position as shown in the figure, then tilt up to allow the opening of the doors. WARNING: Retain the cabinet with an hand to prevent its falling down.</p>	<p>B</p>  <p>Riportare il mobile in posizione verticale. Rimuovere i componenti da dentro il mobile. Bring the cabinet in a vertical position. Remove the equipments within the cabinet.</p>
<p>C</p>  <p>Montare le maniglie (fig.3) sulle ante utilizzando le viti 4x20 (fig.4). Tenere la maniglia in corrispondenza dei rispettivi fori sulla parte esterna dell'anta ed inserire le viti nei fori posti all'interno, quindi fissare la maniglia avvitando con il cacciavite. Ripetere l'operazione con le altre ante. Mount the handles (fig.3) on doors using screws 4x20 (fig.4). Support the handle above the respective holes on the outside of the door and insert the screws in the holes on the inside, and then set the handle screwing with the screwdriver. Repeat this operation with the other doors.</p>	<p>D</p>  <p>Chiudere le ante a posizionare il mobile in posizione orizzontale su una superficie piana. Close the doors and place the cabinet in a horizontal position on a flat surface.</p>

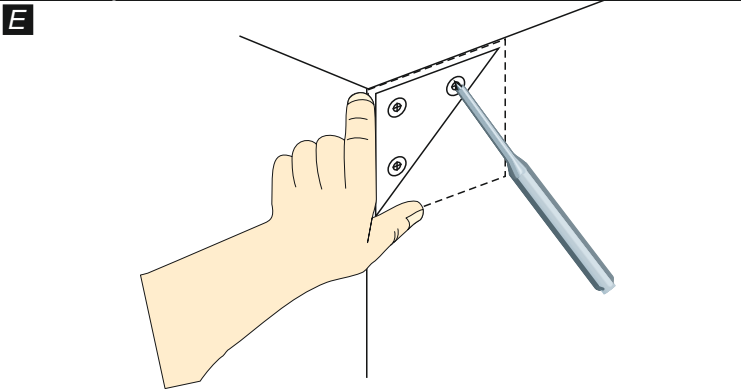

Utilizzare la sagoma ritagliata precedentemente fornita insieme ai piedi e posizionarla su un angolo della base. Fare dei fori nei tre centri con un punteruolo per agevolare la penetrazione delle viti. Ripetere l'operazione sugli altri angoli.

ATTENZIONE: agire sulla base, non sul top.

*Use the shape cropped previously supplied with the feet and turning on the corners of the base flush with the sides. Mark the holes in the three centers with an awl to facilitate the penetration of the screws. Repeat the operation on the other corners. **WARNING: act on the base, not on the top.***

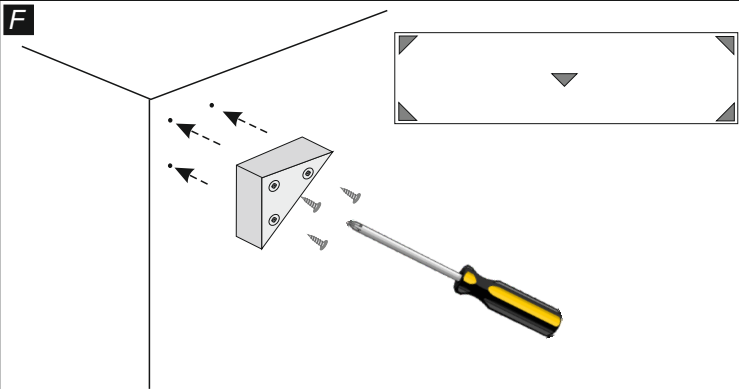

Posizionare ora il piede (fig.1) sui fori segnati sull'angolo della base come mostrato in figura. Fissare il piede con le viti 4,5x16 (fig.2) (3 viti per piede). Ripetere l'operazione sugli altri angoli con i restanti piedi. I restanti piedi vanno fissati centralmente sulla base.

Support now the foot (fig.1) on the holes marked on the corner of the base on respective holes shown of the foot. Fix the foot using screws 4,5x16 (fig.2) (3 screws for foot). Repeat the operation on the other corners with the remaining feet. The remaining feet should be placed centrally on the base.

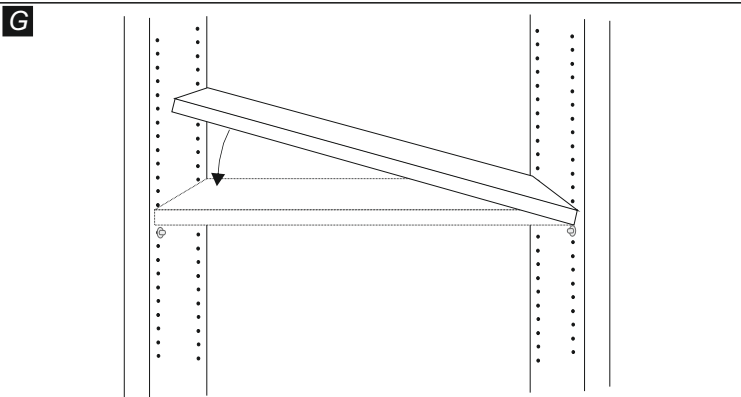

Inserire il ripiano inclinato sui reggipiani (5) inseriti precedentemente sui fianchi, quindi riportare in posizione orizzontale il ripiano.

Slip now inclined shelf above the supports (5) previously inserted on sides, tilting between the sides in the area above the supports, then back in a horizontal position.

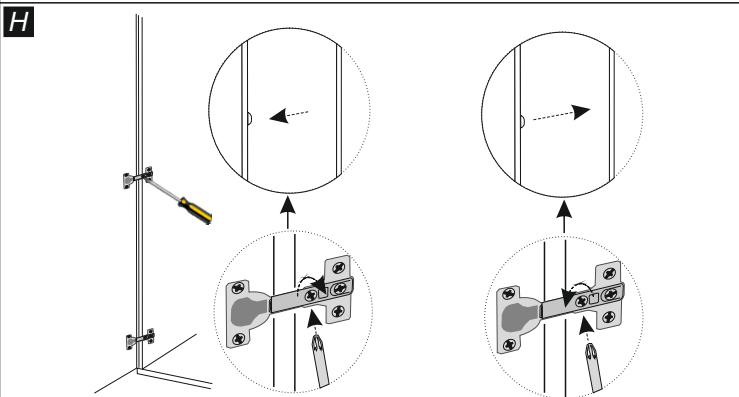

Se l'apertura/chiusura delle ante non è perfetta, è necessario agire con il cacciavite sulla vite posta al centro delle cerniere, avvitando e/o svitando leggermente. In relazione al senso di rotazione della vite sulla cerniera, l'anta si avvicina o allontana dal fianco del mobile.

If the opening/closing of the doors is not perfect, it is necessary to act with a screwdriver on the screw in the center of the doors hinges, with short turn screwing/unscrewing. According to the direction with which turns the screw of the hinge, the door is approaching or farther away from their side of cabinet.



Scheda Prodotto / Product Sheet

PRODOTTO PRODUCT	COMPONENTI COMPONENTS	TIPOLOGIA E MATERIALI PER LA STRUTTURA TYPOLOGY AND MATERIAL FOR THE STRUCTURE	TIPOLOGIA E MATERIALI DI RIVESTIMENTO SUPERFICI TYPOLOGY AND COATING MATERIAL SURFACES	TIPOLOGIA E MATERIALI PER I BORDI TYPOLOGY AND MATERIAL FOR THE EDGES
Mobile multiuso Cabinet	Fianchi Sides	Truciolare nobilitato Engineered wood	Carta impregnata come resine melaminiche Paper impregnated with melanine resins	Carta impregnata con resine termoplastiche e termoindurenti o PVC Paper impregnated with thermoplastics and thermosetting resins or PVC
	Top			
	Base			
	Cassetti Drawers			
	Schiena Backrest	Pannello fibrolegnoso Panel wood fiber	Trattamento superficiale idrofobizzante con paraffina Surface treatment hydrophobicizing with paraffin	

ALTRE CARATTERISTICHE (EVENTUALI MATERIALI E SOSTANZE CHE POSSONO ARRECARE DANNO ALL'UOMO E ALL'AMBIENTE) OTHER CHARACTERISTICS (ANY MATERIALS AND SUBSTANCES THAT MAY CAUSE DAMAGE TO MAN, THINGS AND THE ENVIROMENT)	USO USE	PULIZIA CLEANING	SMALTIMENTO DISPOSAL
Materiale di classe E1: bassa emissione di formaldeide Material class E1: low formaldehyde emissions	Mobile multiuso Multiuse cabinet	Utilizzare panno inumidito con alcool diluito o con prodotti per la pulizia delle superfici lavabili, purché privi di abrasivi e/o solventi. Use cloth moistened with alcohol diluted or with cleaning products for the washable surfaces, if they are free of abrasives and/or solvents	Al termine del ciclo di vita, il prodotto può essere conferito alla raccolta differenziata o speciali piattaforme RSU At the end of the life cycle the product may be conferred on the differentiated collection or special platforms RSU

ATTENZIONE

Il mobile va appoggiato su superfici perfettamente piane ed addossato ad una parete. Se al momento dell'apertura della confezione dell'imballo si evidenziasse anomalie delle parti strutturali occorre contattare il fornitore prima del suo utilizzo.

WARNING

The cabinet must be supported on surfaces perfectly flat and leaned against a wall.. If at the time of the opening of the packaging, it yields anomalies of structural parts you need to contact the supplier before its use.

SARMOG s.r.l.

Via Pizzamiglia, 7
 42016 S.Girolamo di Guastalla (RE) - Italy

Tel +39 0522 228058
 Fax +39 0522 228442

Web www.sarmog.com
 E-mail info@sarmog.com

SARMOG
 L I F E S T Y L E H O M E